

The Kirsch logo is positioned in the upper left corner of the image. It features the brand name 'Kirsch' in a white, serif font, with a red swoosh underline that starts under the 'i' and curves under the 'h'.

Kirsch



**Veneciana Aluminio  
y madera sistema 25**

# Veneciana Aluminio y madera

## Sistema 25

### Componentes base

Cabezal 25mm / Precios: €/ud/mt

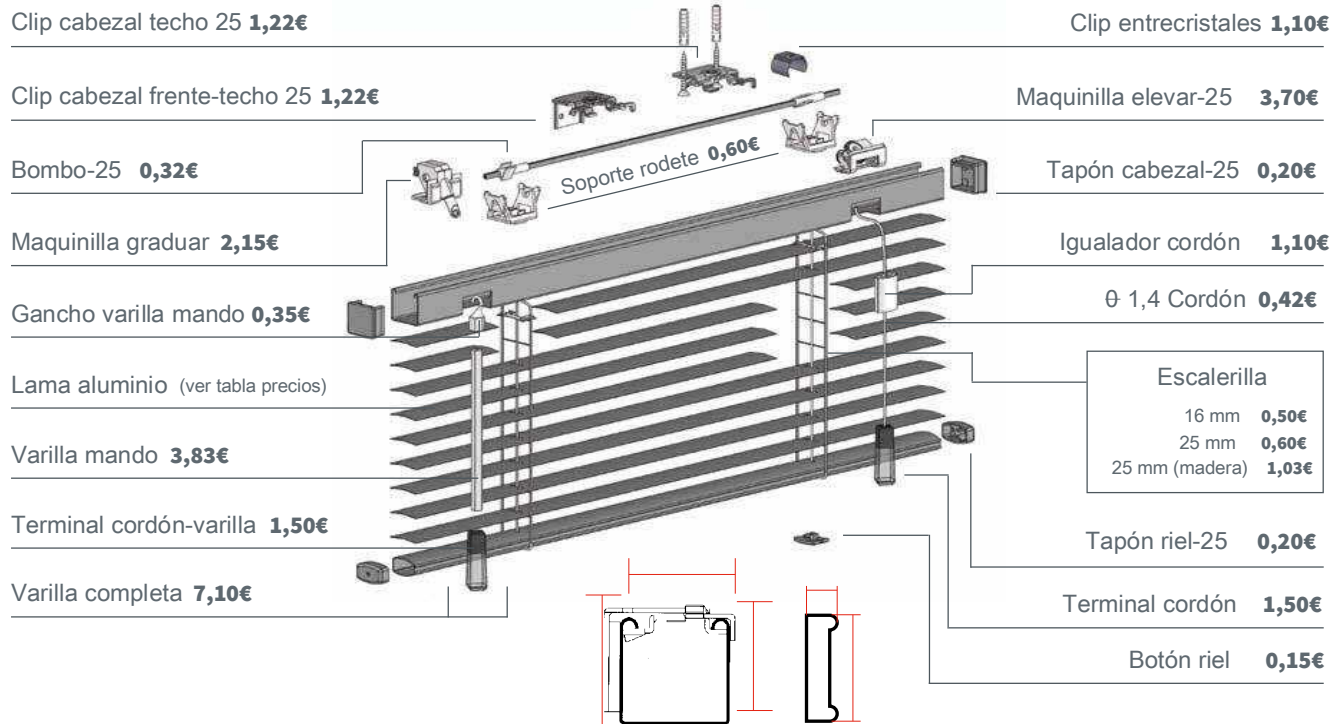

### Límites dimensionales

	Micro	Riviera	Riviera madera
<b>Lama</b>	16 mm	25 mm	25 mm
Anchura mínima	36 cm con mandos a un lado 22 cm con mandos a ambos lados		
Anchura máxima	3,00 m	3,00 m	1,20 m
Altura mínima	Sin mínimos		
Altura máxima	2,50 m	3,00 m	1,60 m

### Altura plegada

	Micro	Riviera	Riviera madera
<b>Lama</b>	16 mm	25 mm	25 mm
Cálculo	4% + 3 cm	3% + 5 cm	14% + 5 cm

## Precios

Precios con cabezal de 25 mm		16 mm	25 mm
Aluminio	Colores base	64€/m2	46€/m2
	Imitacion Madera		84€/m2
	Mates		61€/m2
	Perforados		79€/m2
	Bicolor		49€/m2
Madera	Colores base		260€/m2

\* A efectos de facturación, las medidas se redondearan en múltiplos de 5cm a la alza. Mínimo a facturar 1,5m

## Incrementos



Escuadra 6,4 cm **3,02€/ud**



Escuadra 14 cm **4,16€/ud**



Escuadra 16 cm reforzada **18,50€/ud**



Clip acoplamiento **2,38€/ud**



Clip oscilante pared **12,50€/ud**



Clip oscilante guía cable **12,50€/ud**

## Motorización

Motor LV-B-64 | Motor LW-B-83

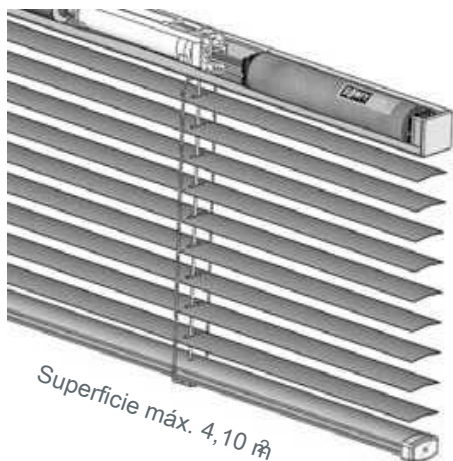

### Con pulsador y transformador



Motor **somfy** 265€  
Pulsador-transformador integrado 230/24V 200€

\* Ancho mín:  
Hasta 2,20m de alto: 59 cm  
De 2,20m a 3,00m de alto: 65 cm

### Con mando a distancia

Motor **somfy** 450€  
Transformador 230/24V 125€  
Mando 1 canal 150€  
Mando 4 canales 180€

\* Ancho mín:  
Hasta 2,20m de alto: 65 cm  
De 2,20m a 3,00m de alto: 0,73 cm

# Veneciana Aluminio y madera

## Sistema 25

### Monocomando

**Manivela**

Final carrera **54,00€**

Conjunto elevación **39,00€**

Piñon fijo **112,00€**

Varilla eje 6mm **2,60€**

Piñon libre **101,21€**

Manivela

Precio conjunto **225€**

Fija: **62,50€**  
Con embrague **80,10€**  
Estándar

ancho mínimo 55 cm

**Cadena**

Conjunto elevación **39,00€**

Varilla eje 6mm **2,60€**

Conjunto accionamiento **108€**  
(blanco o gris)

Cadena cerrada

0,60	<b>2,30€</b>
1,20	<b>3,50€</b>
1,50	<b>4,20€</b>
2,45	<b>6,45€</b>

Precio conjunto **60,00€**

metros

### Entrecristales

**Mando varilla flexible**

Clip cabezal **1,10€**

Salida mando **0,90€**

Espárrago torsión **0,90€**

Varilla flexible

80 cm	<b>4,64€</b>
100 cm	<b>5,42€</b>

Soporte varilla **0,20€**

Soporte cordón **0,50€**

Precio conjunto **Sin cargo**

ancho mínimo 9 cm

**Mando botón**

Clip cabezal **1,10€**

Conjunto cable

1,00 m	<b>7,15€</b>
1,20 m	<b>7,40€</b>
Estándar 1,50 m	<b>8,30€</b>
2,00 m	<b>9,60€</b>
2,50 m	<b>1,50€</b>

Conjunto botón **8,60€**

Precio conjunto **20,00€**

Estándar (blanco o gris)

ancho mínimo 9 cm

### Opciones sujeción

**Sujeción riel**

Pivote riel **0,20€**

Escuadra riel **0,20€**

Precio conjunto **10,00€**

\* El riel será siempre 1,30 cm más corto por cada lado

**Guía a cable**

Tensores **0,70€**

Muelle tensor **0,50€**

Cable acero 0,93 **1,20€**

Pivote ojal **1,26€**

Escuadra	<b>4,20€</b>
Circular	<b>2,83€</b>
Soporte	<b>4,20€</b>

Precio conjunto **20,50€**

\* Ancho máximo: 16 mm : 130 cm | 25 mm : 140 cm  
\* El riel será siempre 1,70 cm más corto por cada lado

ancho mínimo 40 cm

## Colores básicos

 <b>1101</b> 16 25 50	 <b>1102</b> 16 25	 <b>1103</b> 16 25	 <b>1104</b> 16 25
 <b>1151</b> 16 25 50	 <b>1159</b> 25 50	 <b>1160</b> 25 50	 <b>1161</b> 25 50
 <b>1105</b> 16 25	 <b>1106</b> 16 25	 <b>1156</b> 25	 <b>1150</b> 16 25
 <b>1152</b> 16 25	 <b>1153</b> 16 25	 <b>1108</b> 16 25	 <b>1109</b> 25 50
 <b>1157</b> 25	 <b>1110</b> 16 25	 <b>1111</b> 16 25	 <b>1112</b> 16 25
 <b>1154</b> 25	 <b>1115</b> 25	 <b>1123</b> 16 25	 <b>1124</b> 16 25

# Veneciana Aluminio y madera











## Sistema 25



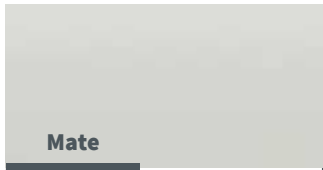

### Colores básicos

 1125 25	 1121 25	 1127 16 25	 1118 25
 1158 25	 1128 16 25	 1129 16 25	 1130 16 25
 1131 16 25	 1132 25 50	 1133 25	 1134 25
 1136 25	 1140 25	 1139 16 25 50	 1141 25
 1142 25	 1144 25	 1145 25	 1146 25
 1147 25	 1148 16 25	 1149 16 25	

## Colores especiales

 <b>Imitación madera</b>	 <b>Imitación madera</b>	 <b>Imitación madera</b>
<b>1214 E</b> 25	<b>1215 E</b> 25	<b>1213 E</b> 25
 <b>Perforado</b>	 <b>Perforado</b>	 <b>Perforado</b>
<b>1301 P</b> 25	<b>1302 P</b> 25	<b>1304 P</b> 25
 <b>Mate</b>	 <b>Mate</b>	 <b>Mate</b>
<b>1223 M</b> 25	<b>1224 M</b> 25	<b>1229 M</b> 25
 <b>Mate</b>	 <b>Mate</b>	 <b>Mate</b>
<b>1230 M</b> 25	<b>1231 M</b> 25	<b>1232 M</b> 25

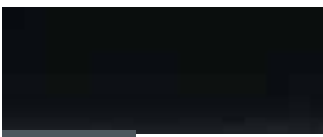
## Bicolor

 <b>1401 BI</b>	 <b>1402 BI</b>
25	25
 <b>1403 BI</b>	
25	







Kirsch



**Veneciana Aluminio  
y madera sistema 50**

# Veneciana Aluminio y madera

## Sistema 50

### Componentes base

Cabezal 50 mm. / Precios €/ ud./mt

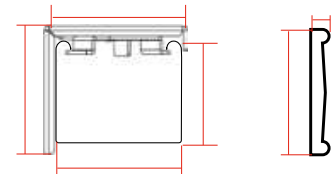
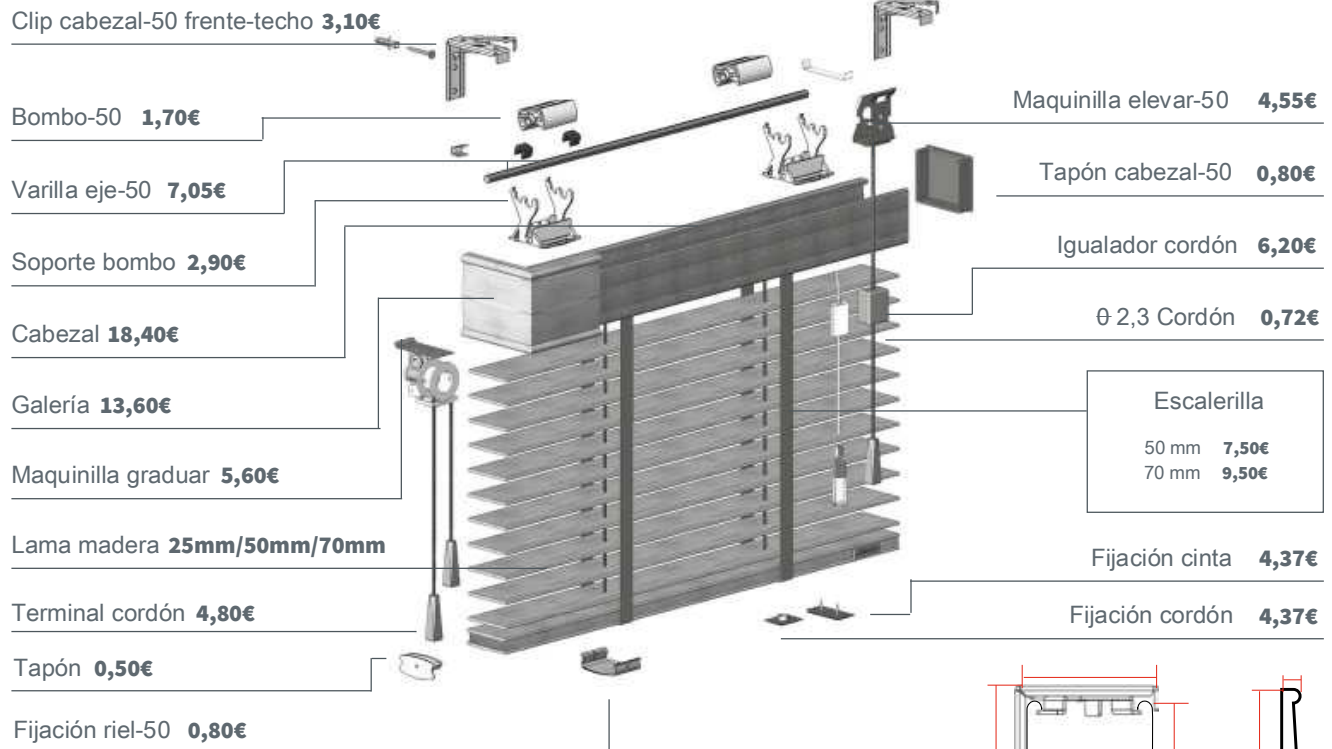

### Límites dimensionales

Lama	50 mm	70 mm
Anchura mínima	ancho mínimo 50 cm. con mandos a un lado; 40 cm con mandos a ambos lados	
Anchura máxima	260 cm	260 cm
Altura mínima	30 Cmts.	

### Altura plegada

Lama	50 mm	70 mm
Cordoncillo	9% + 8 cm	6% + 9 cm
Cinta	10% + 8 cm	7% + 9 cm

## Precios

Precios €/m <sup>2</sup> con cabezal de 50 mm			50 mm	70 mm
Madera	Colores base	Cordoncillo	195,68	267,68
		Cinta	216,32	280,32
	Acabados especiales	Cordoncillo	257,44	
		Cinta	266,72	
Aluminio	Colores base	Cordoncillo	68,64	
		Cinta	76,80	

\* Ver guía de colores disponibles en aluminio en páginas 7, 8 y 9

\* A efectos de facturación, las medidas se redondearan en múltiplos de 5cm a la alza. Mínimo a factura 1,5m

## Galerías



Para incrustar en hueco

Ancho de lama +1cm de cabezal

Instalación pared o techo

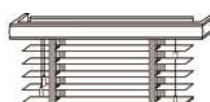

Forma U - mayor que lamas

Ancho de lama +3cm de cabezal

Ancho lateral: 7,2cm

Instalación pared o techo

**Estándar**



Para doble ambiente

Ancho de lama +3cm de cabezal

Ancho lateral: 8,2cm

Instalación solo techo

## Motorización

### Motor SONESSE 220V

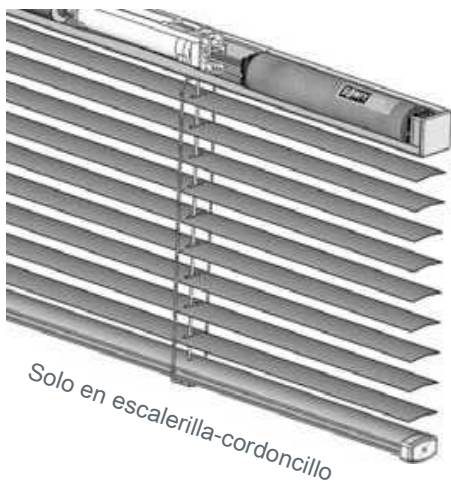

### Con pulsador



Motor mecánico 9N **somfy**

429€

Pulsador-transformador integrado orientador lama

245€

\* Incluye caja de superficie

### Mando a distancia con receptor



Motor **somfy**

575€

Mando 1 canal

150€

Mando 4 canales

180€

\* Ancho mín: 0,64m. ancho máx: 2,40 m.





# Veneciana Madera

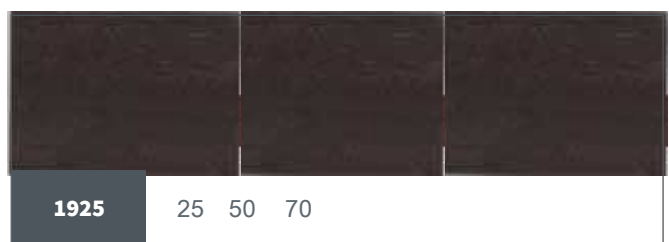
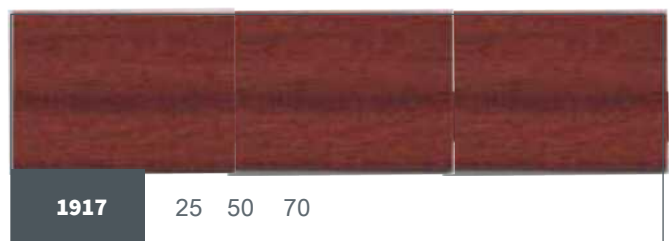
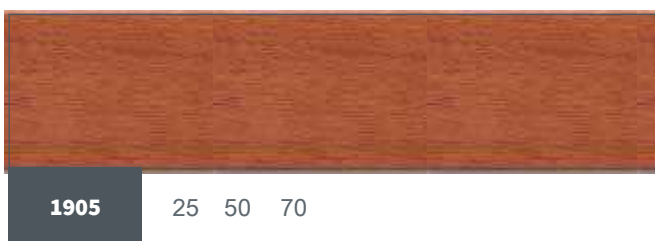
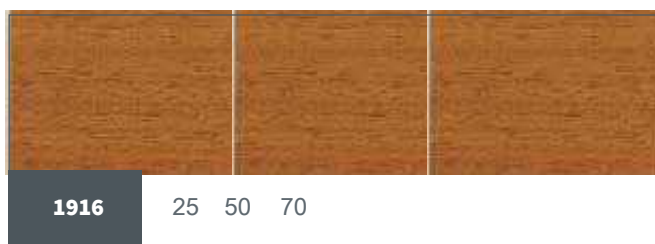
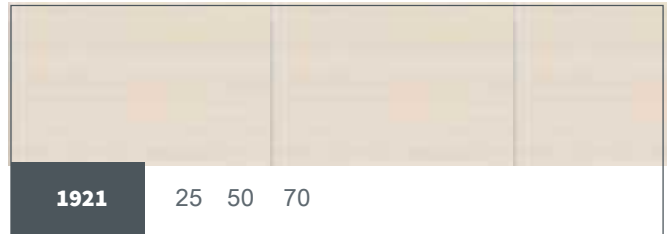
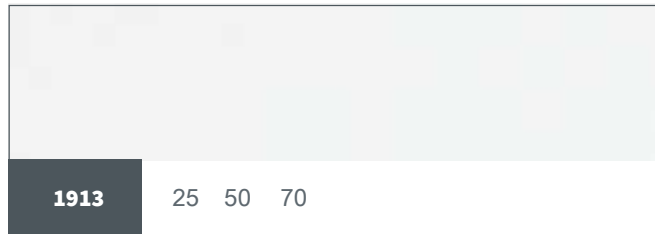

## Madera básica

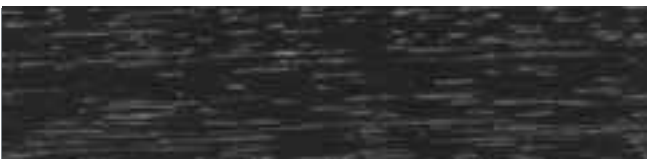

## Madera especial

	<b>1926</b>	50		<b>1927</b>	50
	<b>1928</b>	50		<b>1929</b>	50
	<b>1930</b>	50		<b>1931</b>	50

## Cintas

	<b>001</b>	1913 1926 Aluminio 1101		<b>015</b>	1921 1927		<b>011</b>	1914 1915		<b>009</b>	1916		<b>008</b>	1922 1905
	<b>010</b>	1917		<b>003</b>	1923		<b>013</b>	1924		<b>007</b>	1907 1925			
	<b>002</b>	1928		<b>014</b>	1929 Aluminio 1159-1160		<b>016</b>	1930 Aluminio 1161		<b>006</b>	1931			